

Varenummer: 03555050

Beskrivelse: Fluro hydraulik ledhoved FS 50C

Mål

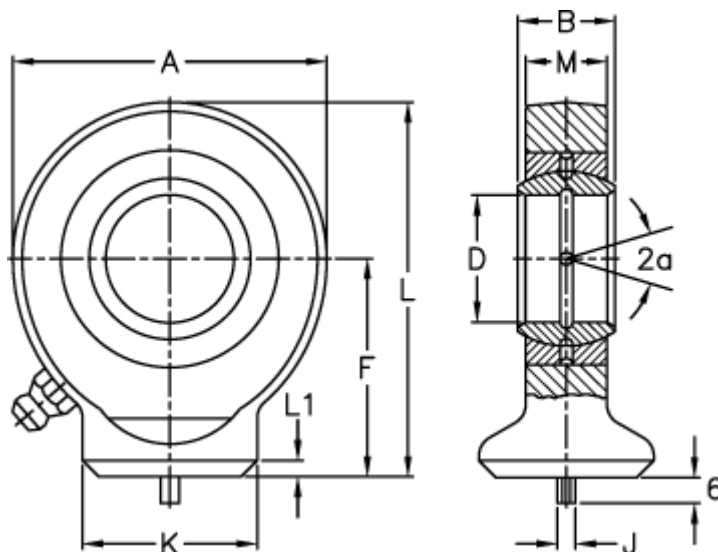

A	= 112	L	= 144
a (grader)	= 6	L1	= 6
B	= 35	M	= 30
D	= 50	Statisk belastning C0 (kN)	= 250
Dynamisk belastning C (kN)	= 156	Vægt	= 2650
F	= 88		
J	= 6		
K	= 62		